

Featuring
Improved

Cycle Time
Roughness
Position Accuracy
True Roundness

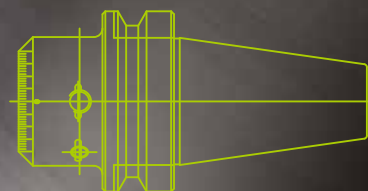

HIGH SPEED *Nine9*[®] BORING BARS

High Efficiency/Easy Adjustment

THE ACCURATE &
ADVANTAGED SOLUTION

www.jic-tools.com.tw



Cat.No.9



Global Marketing >>

We have
invested resources
in the design
&
Manufacture
of inserted cutters

Our innovative tooling design upgrades productivity and competitive capability while reducing production requirements in a wide range of industries.

The tooling system is designed to benefit users of machining centers and CNC lathe, turning center and special purpose machines.

Our outstanding R&D capabilities combined with fast delivery provide a strong competitive edge.



Introduction of EMB Boring Bar



What are EMB Boring Bars ?

EMB boring bars are “Eccentric Mechanism Boring bars” which can adjust to required diameter via an eccentric mechanism. The boring bar is not at the center of the holder, but offset from the center.

Patent No:108599(Taiwan), ZL96201178.9(China)
I265836(Taiwan), ZL200510101469.5(China), US 7455487 B2(USA)

EMB Boring Bars Family

- 00-99101: 0.03 mm/div. adjustment range ± 0.5
- 00-99121: 0.01 mm/div. adjustment range ± 0.1
- 00-99111: 0.01 mm/div. & 0.03 mm/div. Interchangeable type.
- 00-99146: 0.01 mm/div. adjustment range ± 0.12
 $\varnothing 5\text{mm} \sim \varnothing 50\text{mm}$ boring bars are interchangeable.
 G6.3, 10000 r.p.m.



00-99101
00-99121



00-99111-01xx
00-99111-03xx



00-99146-BT30
00-99146-BT40
00-99146-BT50
00-99146-CAT40
00-99146-SK40
00-99146-HSK63A



00-99146-01-32HB



00-99151A-xxxxW

USA Patent

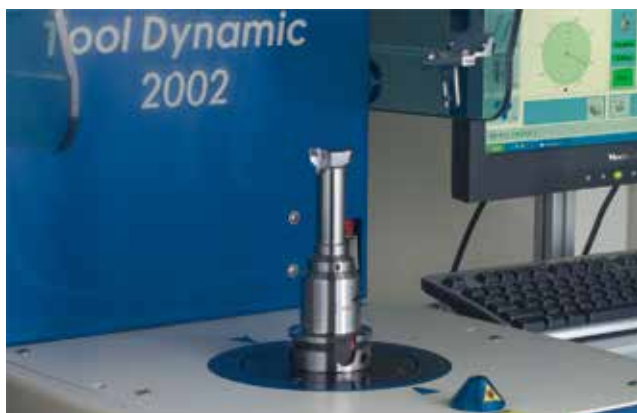

00-99146-xx
Interchangeable boring bar
Standard balanced grade
10000 r.p.m. G6.3
both of shank and bar.

EMB Boring Bars

Side lock holders
Hydraulic chucks
Spring collet chucks

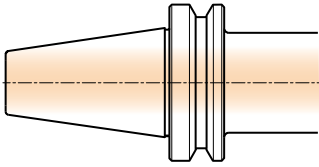

00-99101-07...25
00-99121-05...25
page:4,5

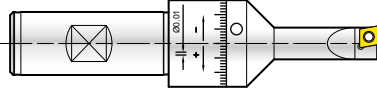

00-99111-01-05...25
page:6,7

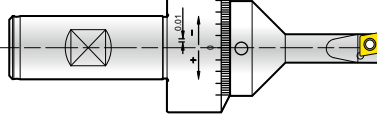

Dia. 5...25 mm

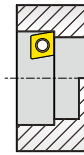

Insert

CCGT030102
CCGT040102
CCGH060204
page:16

Quick Change High Speed Boring Bars

Solid Carbide Shank page:15
00-99151-xxxxW

Dia. 4.87...6.87 mm

Dia. 6.87...8.87 mm

Dia. 8.87...11.12 mm

Dia. 11.87...14.12 mm

Dia. 14.87...20.12 mm

Dia. 4.87...20.12 mm



Insert

CCGT030102
CCGT040102
CCGH060204
page:16

00-99151A-04...15.5
Adapter
page:15

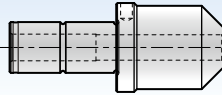

Quick Change
Adjustment boring head shank

DIN 69871 SK40A
JIS 6339/MAS BT 30/40/50
ANSI CAT40
DIN 69893 HSK63A
Side lock Ø32mm

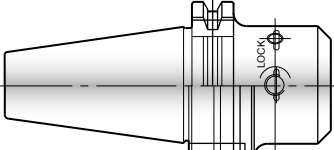

00-99146-xxxH page:10

00-99146-xxA page:11 Dia. 5...10 mm

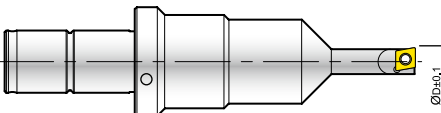

00-99146-xxA page:11 Dia. 11...25 mm

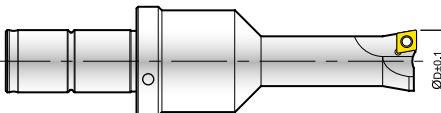

00-99146-xxA page:12 Dia. 26...39 mm

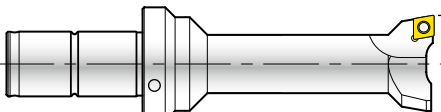

00-99146-xxA page:12 Dia. 40...50 mm

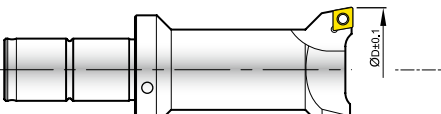

Dia. 5...50 mm

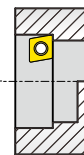

Insert

CCGT030102
CCGT040102
CCGH060204
page:16

Micro Adjustable Fine Boring Unit

Any available shank

Micro Adjustable Fine Boring Unit
00-99148-xxxx [page:18](#)

Dia. 25.7-60.6 mm

Any ISO Insert

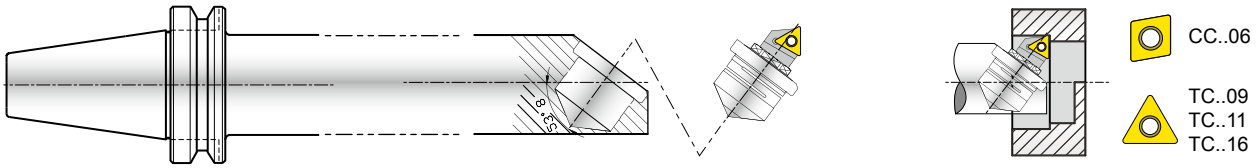

Screw-fit Boring Head and Extension Bar

Hydraulic chucks
Spring collet chucks

Alloy Steel Shank

Direct adjustment Boring head

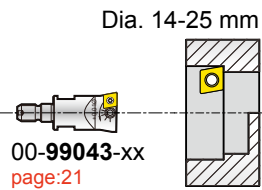
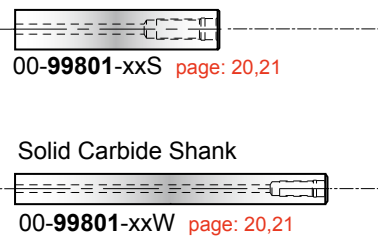
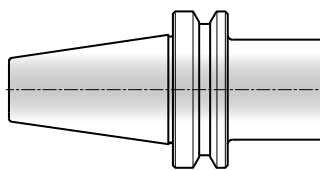

Insert
CCGH060204

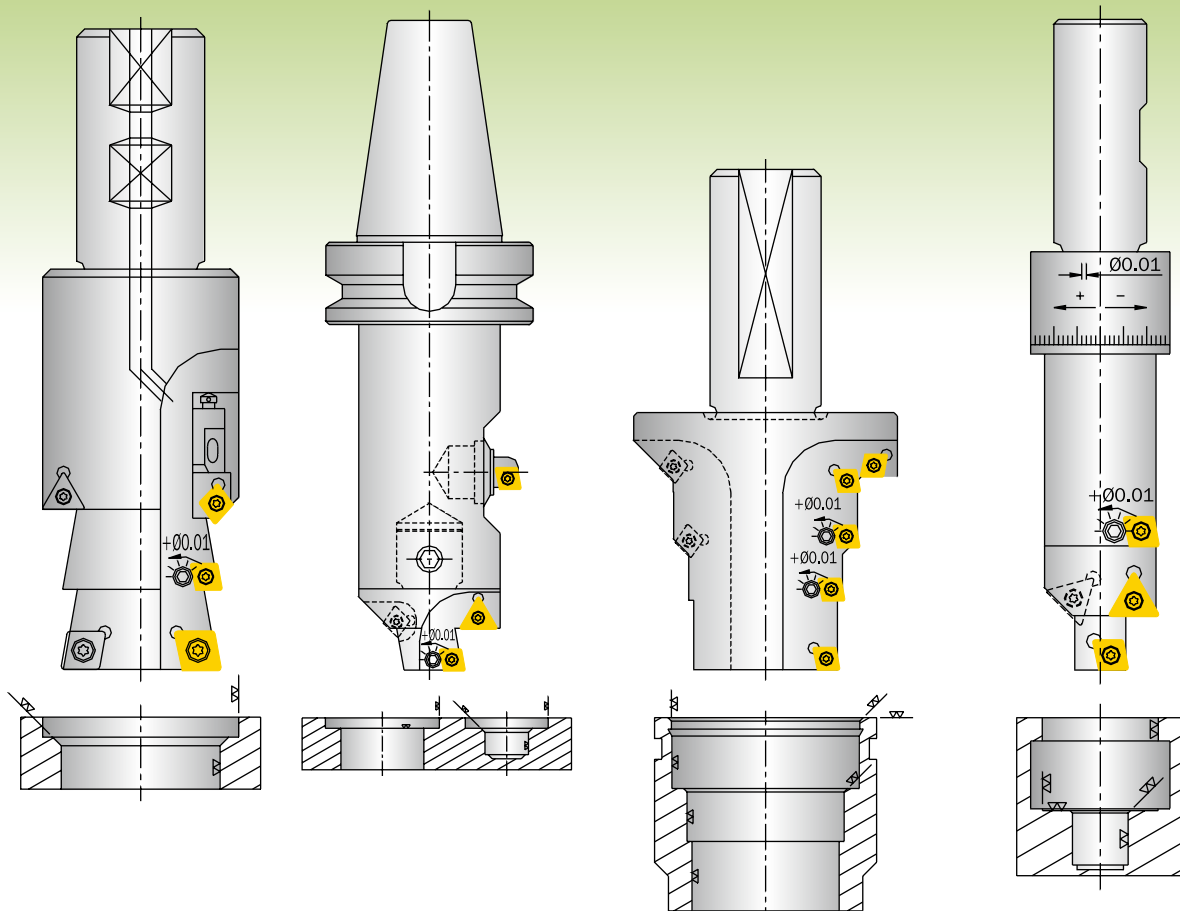

Mechanical Design

- Adjusted by eccentric mechanism, it is simple and backlash free.
(Patented in ROC Taiwan, patent no. 108599, PR China ZL96 2 01178.9)
- It can replace end mill and brazed tool bits.

Easy Handling

- Each division 0.03mm shown on the tools, they are adjustable on the tool presetter or machine easily.
- Total adjustment range ± 0.5 mm

Economic

- Low cost, high efficiency.
- The indexable insert allows a variety of materials to be cut .

Application

- Minimum readout division is 0.03 mm, it is easy for setting up fine boring.
- Ideal as small hole boring tool with excellent accuracy.
- For fine boring operation on milling machines, machining centres and special purpose machines.

- * H type with internal coolant can be ordered on request from Dia. 7mm.
Ordering example: 00-99101-07H.
- * Other sizes are available on request.

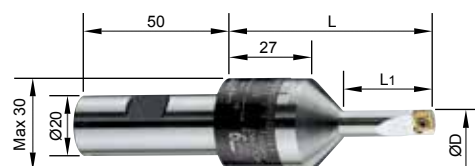
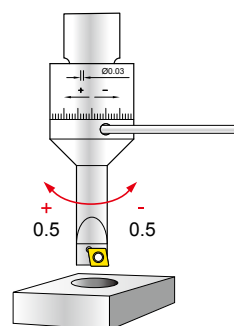

Ordering Code	Part No.		ØD	L1	L	Insert	Screw & Key
00-99101-07	SB20-0721-03	Adjustment range: ± 0.5 mm Each Division 0.03mm	6.5-7.5	21	60	CCGT040102	NK-T6 NS-20036
00-99101-08	SB20-0824-03		7.5-8.5	24	63		
00-99101-09	SB20-0927-03		8.5-9.5	27	65		
00-99101-10	SB20-1030-03		9.5-10.5	30	68	CCGH060204	NK-T7 NS-25045
00-99101-11	SB20-1133-03		10.5-11.5	33	70		
00-99101-12	SB20-1236-03		11.5-12.5	36	73		
00-99101-13	SB20-1339-03		12.5-13.5	39	75		
00-99101-14	SB20-1442-03		13.5-14.5	42	78		
00-99101-15	SB20-1545-03		14.5-15.5	45	80		
00-99101-16	SB20-1648-03		15.5-16.5	48	83		
00-99101-17	SB20-1751-03		16.5-17.5	51	85		
00-99101-18	SB20-1850-03		17.5-18.5	50	82		
00-99101-19	SB20-1950-03		18.5-19.5	50	82		
00-99101-20	SB20-2050-03		19.5-20.5	50	82		
00-99101-21	SB20-2150-03		20.5-21.5	50	82		
00-99101-22	SB20-2250-03		21.5-22.5	50	82		
00-99101-23	SB20-2350-03		22.5-23.5	50	82		
00-99101-24	SB20-2450-03		23.5-24.5	50	82		
00-99101-25	SB20-2550-03		24.5-25.5	50	82	CCGH060204	NK-T7 NS-25060

99121 EMB Boring Bars 0.01 mm/div.

Mechanical Design

- Adjusted by eccentric mechanism, it is simple and backlash free.
(Patented in ROC Taiwan, patent no. 108599, PR China ZL96 2 01178.9)
- It can replace end mill and brazed tool bits.

Easy Handling

- Each division 0.01mm shown on the tools, they are adjustable on the tool presetter or machine easily.
- Total adjustment range ± 0.1 mm

Economic

- Low cost, high efficiency.
- The indexable insert allows a variety of materials to be cut .

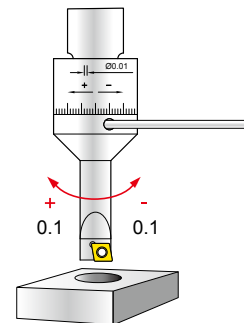

Application

- Minimum readout division is 0.01 mm, it is easy for setting up fine boring.
- Ideal as small hole boring tool with excellent accuracy.
- For fine boring operation on milling machines, machining centres and special purpose machines.

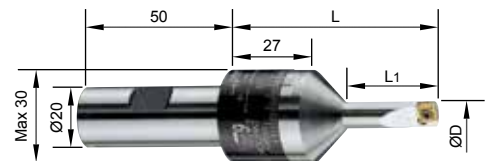

- * H type with internal coolant can be ordered on request from Dia. 7mm.
Ordering example: 00-99101-07H.
- * Other sizes are available on request.

Ordering Code	Part No.		ØD	L1	L	Insert	Screw & Key
00-99121-05	SB20-0515-01	Adjustment range: ± 0.1 mm Each Division 0.01mm	4.9-5.1	15	54	CCGT030102	NK-T6 NS-16030
00-99121-06	SB20-0618-01		5.9-6.1	18	57		
00-99121-07	SB20-0721-01		6.9-7.1	21	60		
00-99121-08	SB20-0824-01		7.9-8.1	24	63	CCGT040102	NK-T6 NS-20036
00-99121-09	SB20-0927-01		8.9-9.1	27	65		
00-99121-10	SB20-1030-01		9.9-10.1	30	68	CCGH060204	NK-T7 NS-25045
00-99121-11	SB20-1133-01		10.9-11.1	33	70		
00-99121-12	SB20-1236-01		11.9-12.1	36	73		
00-99121-13	SB20-1339-01		12.9-13.1	39	75		
00-99121-14	SB20-1442-01		13.9-14.1	42	78		
00-99121-15	SB20-1545-01		14.9-15.1	45	80		
00-99121-16	SB20-1648-01		15.9-16.1	48	83		
00-99121-17	SB20-1751-01		16.9-17.1	51	85		
00-99121-18	SB20-1850-01		17.9-18.1	50	82		
00-99121-19	SB20-1950-01		18.9-19.1	50	82		
00-99121-20	SB20-2050-01		19.9-20.1	50	82		
00-99121-21	SB20-2150-01		20.9-21.1	50	82		
00-99121-22	SB20-2250-01		21.9-22.1	50	82		
00-99121-23	SB20-2350-01		22.9-23.1	50	82		
00-99121-24	SB20-2450-01		23.9-24.1	50	82		
00-99121-25	SB20-2550-01		24.9-25.1	50	82	CCGH060204	NK-T7 NS-25060

Easy adjustment mechanism:

- The boring head adapter is 20mm shank; the receiving hole is eccentric from the center of the shank. The diameter is adjusted by rotating the boring bar.
- Boring bar has preloaded by spring and M6 screw to fix boring bar and adapter together securely. The recommended torque is 0.9-1.0 Nm.
- Boring bar is locked by M8 setscrew; clamping torque is 8-9 Nm.
- Repair and replace boring bars easily.

Economical

- The e-boring bar is more economical than solid carbide reamer. Nine 9 e-boring bars are adjustable to compensate the wearing of insert, but the solid carbide reamer has to be replaced by new reamer.

Applications

- For fine boring operation to get IT7 tolerance; Using Nine9 fine ground inserts, tolerance IT6 is also possible.
- To replace solid carbide reamer for machining precise hole for dowel pin and other small diameter applications; this should be done by reamer in traditional.

Procedures For Assembly

1. Use 4 mm allen-key to **loosen locking screw M8**, take care not to remove the screw.
2. Use 3 mm allen-key to **loosen pre-load screw M6**, take care not to remove the screw.
3. Remove the original boring bar and insert the new boring bar.
4. **Tighten the M6 pre-load screw** using the torque screwdriver with hex head key.
(Recommended torque = 0.9~1.0 Nm)
5. Ensure the boring head and boring bar fit together securely.
6. Measure the boring diameter of the boring bar using tool presetter and adjust it to the required diameter.
7. **Tighten the M8 locking screw** using the torque screwdriver with hex head key (Recommended torque = 8~9Nm)

Procedures For Adjustment

1. **Loosen locking screw M8**.
2. Put a 4 mm allen-key into the adjustable driving hole.
3. Turn to “+” to increase and turn to “-” to reduce boring diameter.
4. **Tighten the M8 locking screw** using the torque screwdriver with hex head key.
(Recommended torque = 8~9Nm)

To replace reamer !

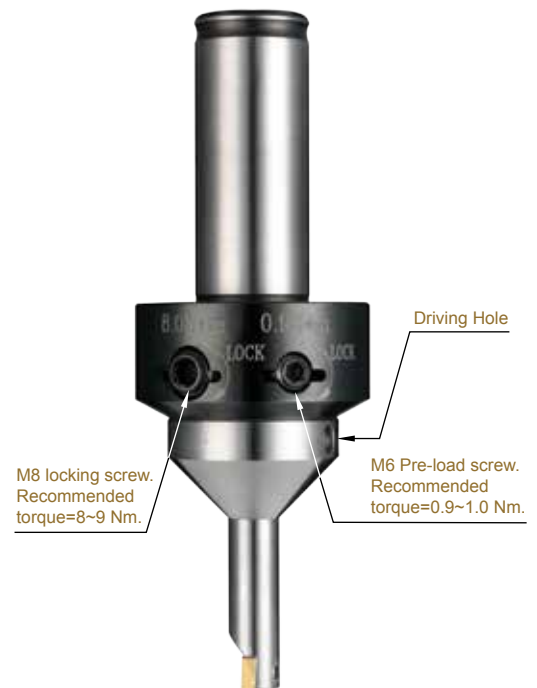

99111 Quick Change e-Boring Bars

Boring Head Adapter

- 2 size adapters are designed for receiving all 00-99111-xxA boring bars.
- Change the boring bar in just one minute.
- 20mm shank to fit any kind of tool holder properly.

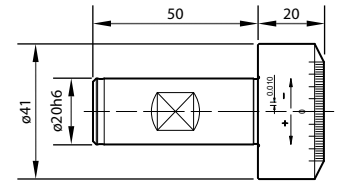

Ordering Code	Part No.	Shank (H6)	Adjustable range	Each division
00-99111-01-20HB	SB20-111-01	20mm	±0.1mm	0.01mm
00-99111-03-20HB	SB20-111-03	20mm	±0.5mm	0.03mm

Interchangeable Boring Bar

- Made by high alloy tool steel, the rigidity is enough for 3xD boring depth.
- All of 00-99111-xxA boring bars are interchangeable to fit same boring head adapter.

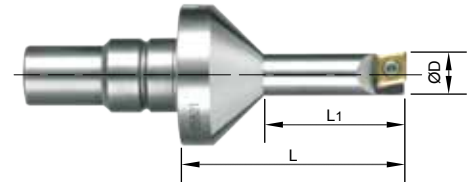

* H type with internal coolant can be order on request.
ordering code:00-99111-07AH

* Other sizes are available on request.

Ordering Code	Part No.	ØD		L1	L	Insert	Key / Screw
		99111-03-20HB	99111-01-20HB				
00-99111-05A	C16-0515	-	4.9-5.1	15	34	CC030102	NK-T6 NS-16030
00-99111-06A	C16-0618	-	5.9-6.1	18	37		
00-99111-07A	C16-0721	6.5-7.5	6.9-7.1	21	40	CC040102	NK-T6 NS-20036
00-99111-08A	C16-0824	7.5-8.5	7.9-8.1	24	43		
00-99111-09A	C16-0927	8.5-9.5	8.9-9.1	27	45	CC060204	NK-T7 NS-25045
00-99111-10A	C16-1030	9.5-10.5	9.9-10.1	30	48		
00-99111-11A	C16-1133	10.5-11.5	10.9-11.1	33	50		
00-99111-12A	C16-1236	11.5-12.5	11.9-12.1	36	53		
00-99111-13A	C16-1339	12.5-13.5	12.9-13.1	39	55		
00-99111-14A	C16-1442	13.5-14.5	13.9-14.1	42	58		
00-99111-15A	C16-1545	14.5-15.5	14.9-15.1	45	60		
00-99111-16A	C16-1648	15.5-16.5	15.9-16.1	48	63	CC060204	NK-T7 NS-25060
00-99111-17A	C16-1751	16.5-17.5	16.9-17.1	51	65		
00-99111-18A	C16-1850	17.5-18.5	17.9-18.1	50	62		
00-99111-19A	C16-1950	18.5-19.5	18.9-19.1	50	62		
00-99111-20A	C16-2050	19.5-20.5	19.9-20.1	50	62		
00-99111-21A	C16-2150	20.5-21.5	20.9-21.1	50	62		
00-99111-22A	C16-2250	21.5-22.5	21.9-22.1	50	62		
00-99111-23A	C16-2350	22.5-23.5	22.9-23.1	50	62		
00-99111-24A	C16-2450	23.5-24.5	23.9-24.1	50	62		
00-99111-25A	C16-2550	24.5-25.5	24.9-25.1	50	62		

Easy Handling:

- Dimensions are easy to read. They are indicated on the tools and are easily adjustable on a tool presetter or in machining center.
- No backlash.
- Change the boring bar and set the boring dimension on the tool presetter in just one minute.

Interchangeable Boring Bars from Diameters of 5 mm to 50 mm

- This simple boring tool has minimal components.
- In minutes, the boring bar may be changed and the boring dimension set on the tool presetter.

Low Cost For Machining Small Holes

- The cost of this product is low compared to other micro adjustable boring heads.

High Speed

- Boring bar design ensures accurate high speed boring. Grade balance is G6.3 10000 r.p.m., all sizes are guaranteed.
- Surface speeds of carbide inserts up to 700 m/min.
- Combination bore / chamfer / facing tools can be ordered on request.

Procedures For Assembly

1. Use 4 mm allen-key to **loosen locking screw M8**, take care not to remove the screw.
2. Use 3 mm allen-key to **loosen pre-load screw M6**, take care not to remove the screw.
3. Remove the original boring bar and insert the new boring bar.
4. **Tighten the M6 pre-load screw** using the torque screwdriver with hex head key.
(Recommended torque = 0.9~1.0 Nm)
5. Ensure the boring head and boring bar fit together securely.
6. Measure the boring diameter of the boring bar using tool presetter and adjust it to the required diameter.
7. **Tighten the M8 locking screw** using the torque screwdriver with hex head key (Recommended torque = 8~9Nm)

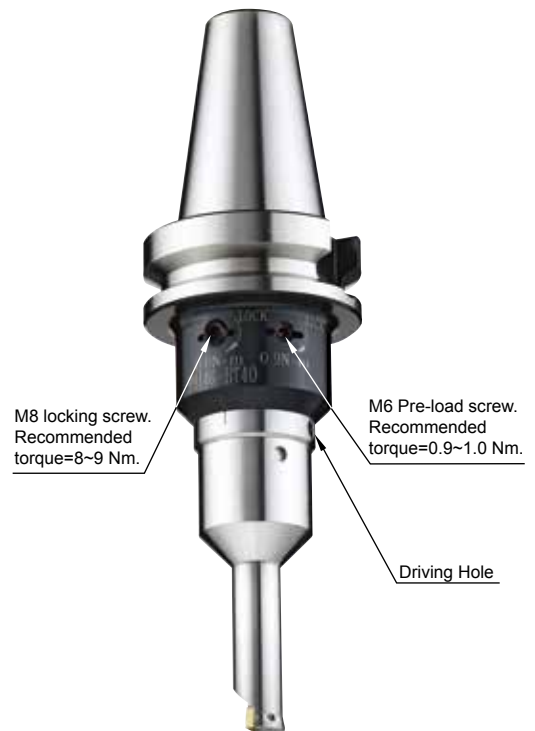

99146 Quick Change High Speed Boring Bar

Procedures For Adjustment

On Tool Presetter

1. Loosen M8 locking screw.
2. Set the boring bar at the neutral position. (Step 1)
3. Measure the boring diameter using the tool presetter and compare with the required diameter. (Step 2)
4. If boring diameter is too big or too small, please put an allen-key into the adjusting driving hole. Turn to “ + ” to increase and turn to “ - ” to reduce boring diameter. (Step 3 and 4)
5. Tighten M8 locking screw.

(Step 1)



(Step 2)



(Step 3)



(Step 4)



To Increase Diameter

To Reduce Diameter

On Milling Machine And Machining Centers

1. Set the boring bar at the neutral position. (Step 1)
2. Tighten M8 locking screw.
3. Test cut on work piece, about 3-5mm depth on the machine.
4. Measuring boring diameter of workpiece and compare with required diameter.
5. If boring diameter is too big or too small, loosen M8 locking screw, please put an allen-key into the adjusting driving hole. Turn to “ + ” to increase and turn to “ - ” to reduce boring diameter. (Step 2 and 3)
6. Tighten M8 locking screw. (Step 4)

(Step 1)



(Step 2)



To Increase Diameter

(Step 3)



(Step 4)



To Reduce Diameter

Boring Head Shank

- Adjustable range: +0.12 /-0.13 mm.
- Each adjustment division is 0.01 mm.
- Balance grade : G6.3 10000 r.p.m.

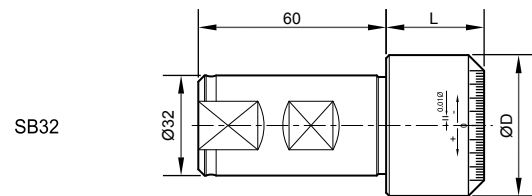
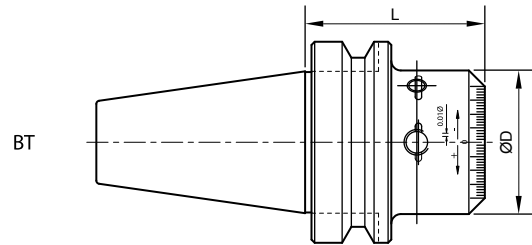
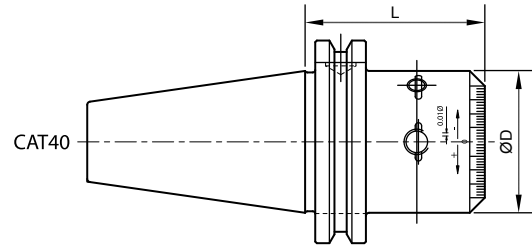
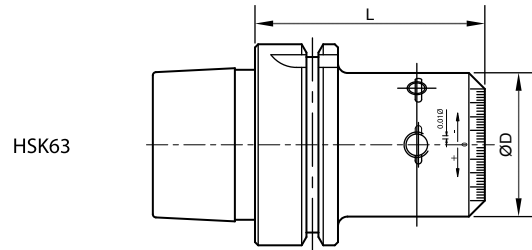
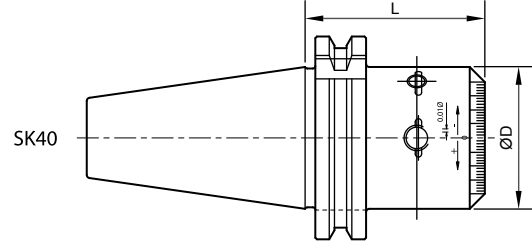

Ordering Code	Part No.	ØD	L
00-99146-SB32HB	SB32-146-31	45	31.3
00-99146-BT30H	BT30-146-51	45	51.3
00-99146-BT40H	BT40-146-56	45	56.3
00-99146-BT50H	BT50-146-77	45	77.3
00-99146-CAT40H	CAT40-146-56	45	56.3
00-99146-HSK63AH	HSK63A-146-72	45	72
00-99146-SK40H	SK40-146-56	45	56.3

99146 Quick Change High Speed Boring Bar

Ø5~Ø25mm

- Alloy Steel Shank
- Boring Depth : L1, 2~3xD

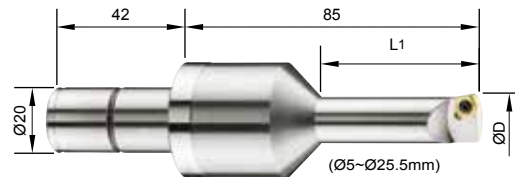

* H type with internal coolant can be ordered on request from Dia. 10mm.

Ordering example: 00-99146-1000SH.

* Other sizes are available on request.

Ordering Code	Part No.	ØD	L1	Insert	Ordering Code	Part No.	ØD	L1	Insert
00-99146-0500S	C20-0500-10L	4.87~5.12	10.00	CCGT030102-NC30 NS-16030, NK-T6	00-99146-1725S	C20-1725-42L	17.12~17.37	42.50	CCGT060204 CCFT060204 Screw: NS-25045 Key: NK-T7
00-99146-0600S	C20-0600-12L	5.87~6.12	12.00		00-99146-1750S	C20-1750-43L	17.37~17.62	43.75	
00-99146-0700S	C20-0700-14L	6.87~7.12	14.00	CCGT040102-NC30 NS-20036, NK-T6	00-99146-1775S	C20-1775-43L	17.62~17.87	43.75	
00-99146-0800S	C20-0800-16L	7.87~8.12	16.00		00-99146-1800S	C20-1800-45L	17.87~18.12	45.00	
00-99146-0900S	C20-0900-18L	8.87~9.12	18.00	00-99146-1825S	C20-1825-45L	18.12~18.37	45.00		
00-99146-1000S	C20-1000-25L	9.87~10.12	25.00	00-99146-1850S	C20-1850-46L	18.37~18.62	46.25		
00-99146-1025S	C20-1025-25L	10.12~10.37	25.00	00-99146-1875S	C20-1875-46L	18.62~18.87	46.25		
00-99146-1050S	C20-1050-26L	10.37~10.62	26.25	00-99146-1900S	C20-1900-47L	18.87~19.12	47.50		
00-99146-1075S	C20-1075-26L	10.62~10.87	26.25	00-99146-1925S	C20-1925-47L	19.12~19.37	47.50		
00-99146-1100S	C20-1100-27L	10.87~11.12	27.50	00-99146-1950S	C20-1950-48L	19.37~19.62	48.75		
00-99146-1125S	C20-1125-27L	11.12~11.37	27.50	00-99146-1975S	C20-1975-48L	19.62~19.87	48.75		
00-99146-1150S	C20-1150-28L	11.37~11.62	28.75	00-99146-2000S	C20-2000-50L	19.87~20.12	50.00		
00-99146-1175S	C20-1175-28L	11.62~11.87	28.75	00-99146-2025S	C20-2025-50L	20.12~20.37	50.00		
00-99146-1200S	C20-1200-30L	11.87~12.12	30.00	00-99146-2050S	C20-2050-50L	20.37~20.62	50.00		
00-99146-1225S	C20-1225-30L	12.12~12.37	30.00	00-99146-2075S	C20-2075-50L	20.62~20.87	50.00		
00-99146-1250S	C20-1250-31L	12.37~12.62	31.25	00-99146-2100S	C20-2100-50L	20.87~21.12	50.00		
00-99146-1275S	C20-1275-31L	12.62~12.87	31.25	00-99146-2125S	C20-2125-50L	21.12~21.37	50.00		
00-99146-1300S	C20-1300-32L	12.87~13.12	32.50	00-99146-2150S	C20-2150-50L	21.37~21.62	50.00		
00-99146-1325S	C20-1325-32L	13.12~13.37	32.50	00-99146-2175S	C20-2175-50L	21.62~21.87	50.00		
00-99146-1350S	C20-1350-33L	13.37~13.62	33.75	00-99146-2200S	C20-2200-50L	21.87~22.12	50.00		
00-99146-1375S	C20-1375-33L	13.62~13.87	33.75	00-99146-2225S	C20-2225-50L	22.12~22.37	50.00		
00-99146-1400S	C20-1400-35L	13.87~14.12	35.00	00-99146-2250S	C20-2250-50L	22.37~22.62	50.00		
00-99146-1425S	C20-1425-35L	14.12~14.37	35.00	00-99146-2275S	C20-2275-50L	22.62~22.87	50.00		
00-99146-1450S	C20-1450-36L	14.37~14.62	36.25	00-99146-2300S	C20-2300-50L	22.87~23.12	50.00		
00-99146-1475S	C20-1475-36L	14.62~14.87	36.25	00-99146-2325S	C20-2325-50L	23.12~23.37	50.00		
00-99146-1500S	C20-1500-37L	14.87~15.12	37.50	00-99146-2350S	C20-2350-50L	23.37~23.62	50.00		
00-99146-1525S	C20-1525-37L	15.12~15.37	37.50	00-99146-2375S	C20-2375-50L	23.62~23.87	50.00		
00-99146-1550S	C20-1550-38L	15.37~15.62	38.75	00-99146-2400S	C20-2400-50L	23.87~24.12	50.00		
00-99146-1575S	C20-1575-38L	15.62~15.87	38.75	00-99146-2425S	C20-2425-50L	24.12~24.37	50.00		
00-99146-1600S	C20-1600-40L	15.87~16.12	40.00	00-99146-2450S	C20-2450-50L	24.37~24.62	50.00		
00-99146-1625S	C20-1625-40L	16.12~16.37	40.00	00-99146-2475S	C20-2475-50L	24.62~24.87	50.00		
00-99146-1650S	C20-1650-41L	16.37~16.62	41.25	00-99146-2500S	C20-2500-50L	24.87~25.12	50.00		
00-99146-1675S	C20-1675-41L	16.62~16.87	41.25	00-99146-2525S	C20-2525-50L	25.12~25.37	50.00		
00-99146-1700S	C20-1700-42L	16.87~17.12	42.50	00-99146-2550S	C20-2550-50L	25.37~25.62	50.00		



99146 Quick Change High Speed Boring Bar

Ø26~Ø39mm

- Alloy Steel Shank
 - Boring Depth : L1, 2~3xD
 - * H type with internal coolant can be ordered on request.
- Ordering example: 00-99146-36AH.

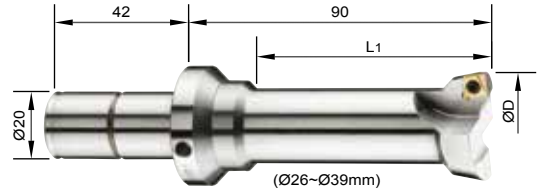

Ordering Code	Part No.	ØD	L1	Insert
00-99146-26A	C20-2600-50L	25.87~26.12	50.00	CCGT060204 CCFT060204 Screw: NS-25060 Key: NK-T7
00-99146-27A	C20-2700-50L	26.87~27.12	50.00	
00-99146-28A	C20-2800-50L	27.87~28.12	50.00	
00-99146-29A	C20-2900-50L	28.87~29.12	50.00	
00-99146-30A	C20-3000-50L	29.87~30.12	50.00	
00-99146-31A	C20-3100-70L	30.87~31.12	70.00	
00-99146-32A	C20-3200-70L	31.87~32.12	70.00	
00-99146-33A	C20-3300-70L	32.87~33.12	70.00	
00-99146-34A	C20-3400-70L	33.87~34.12	70.00	
00-99146-35A	C20-3500-70L	34.87~35.12	70.00	
00-99146-36A	C20-3600-70L	35.87~36.12	70.00	
00-99146-37A	C20-3700-70L	36.87~37.12	70.00	
00-99146-38A	C20-3800-70L	37.87~38.12	70.00	
00-99146-39A	C20-3900-70L	38.87~39.12	70.00	

Ø40~Ø50mm

- Alloy Steel Shank
 - Boring Depth : L1, 2~3xD
 - * H type with internal coolant can be ordered on request.
- Ordering example: 00-99146-45AH.

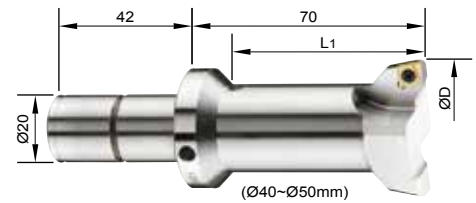

Ordering Code	Part No.	ØD	L1	Insert
00-99146-40A	C20-4000-70L	39.87~40.12	70.00	CCGT060204 CCFT060204 Screw: NS-25060 Key: NK-T7
00-99146-41A	C20-4100-70L	40.87~41.12	70.00	
00-99146-42A	C20-4200-70L	41.87~42.12	70.00	
00-99146-43A	C20-4300-70L	42.87~43.12	70.00	
00-99146-44A	C20-4400-70L	43.87~44.12	70.00	
00-99146-45A	C20-4500-70L	44.87~45.12	70.00	
00-99146-46A	C20-4600-70L	45.87~46.12	70.00	
00-99146-47A	C20-4700-70L	46.87~47.12	70.00	
00-99146-48A	C20-4800-70L	47.87~48.12	70.00	
00-99146-49A	C20-4900-70L	48.87~49.12	70.00	
00-99146-50A	C20-5000-70L	49.87~50.12	70.00	

High Speed Boring Bar Kit

Ordering Code	Contents
00-99146-32HB-05SET	SB32-146-31 Weldon Shank Boring head shank: 1pc Boring bar: any 5 pcs from Ø5~Ø50 Key: 3~5 pcs Plastic box: 1pc
00-99146-BT30-05SET	
00-99146-BT40-05SET	
00-99146-BT50-05SET	
00-99146-CAT40-05SET	
00-99146-SK40-05SET	
00-99146-HSK63A-05SET	



(Insert is not included, please order separately)
• Note: BT50 boring head shank is packed in a separate box.

99146 Quick Change High Speed Boring Bar

Application Example

- Machining a cover of scooter engine:
Work piece material: Die casting, Al-alloy, ADC-12(A383)

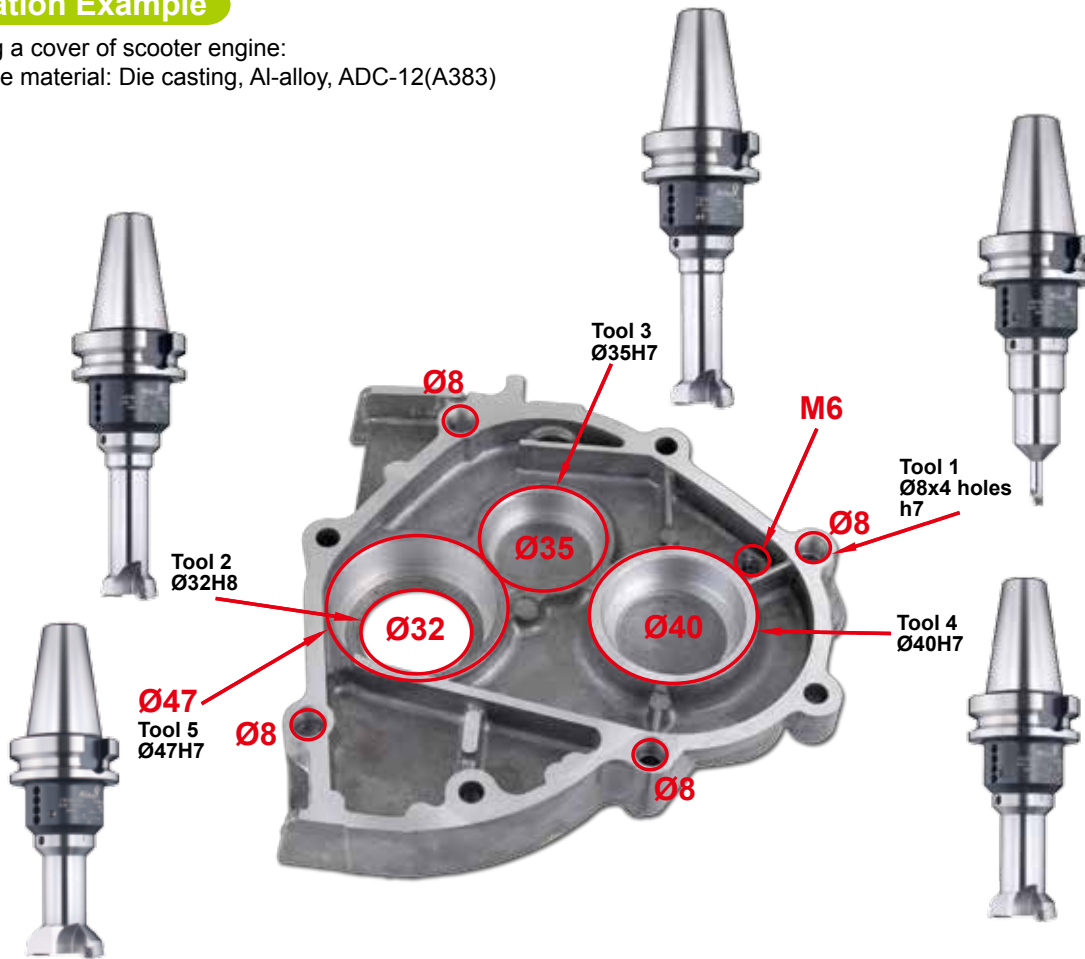

TOOL LIST by Nine9 Boring Bar 99146-series, Spindle Size: BT40

No.	Boring Bar	Grade of insert	Dia. mm	Depth	r.p.m.	F = mm/min.	Machining time
1	00-99146-08A	CCGT040102 NC30	Ø8H7	8 mm	8000	400	1.2 sec.
2	00-99146-32A	CCGT060202HP NC9031	Ø32H8	8 mm	2985	209	2.3 sec.
3	00-99146-35A	CCGT060202HP NC9031	Ø35H7	12 mm	2730	191	3.8 sec.
4	00-99146-40A	CCGT060202HP NC9031	Ø40H7	15 mm	2400	168	5.4 sec.
5	00-99146-47A	CCGT060202HP NC9031	Ø47H7	15 mm	2030	142	6.4 sec.

Working Example

Material	Vc m/min.	f mm/rev.	Roughness			Tool holder	Insert
			Ra	Rz	Rmax		
Al alloy, 6061	150	0.2	0.076µm	0.50µm	0.6µm	99146-BT40-26A	CCGH0602U NC9096

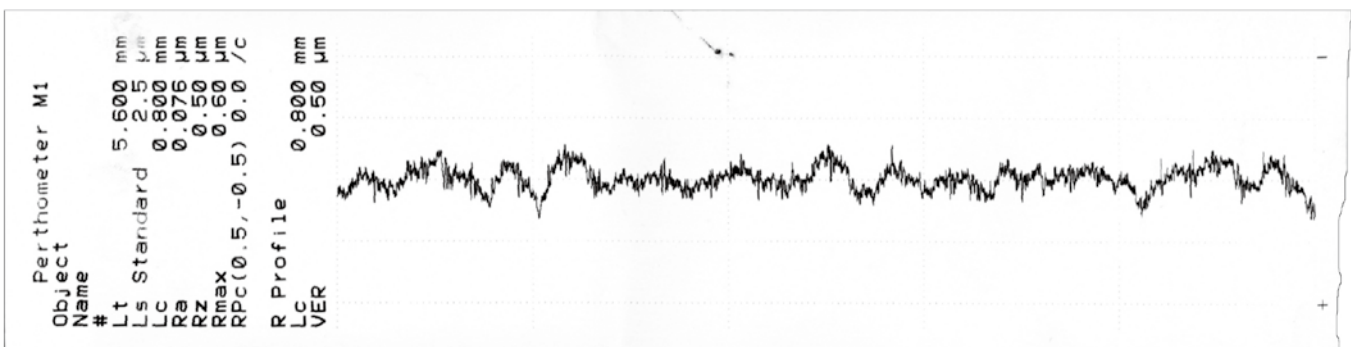

Mechanical Design

- Adjusted by eccentric mechanism, it is simple and backlash free.
(Patented in ROC Taiwan, patent no. I265836, PR China 200510101469.5)
- It can replace end mill and brazed tool bits.

Easy Handling

- Each division is 0.01mm, No back lash.
- 4~6xD boring depth, Good balance condition is maintained .

Economic

- Boring size **below Ø6mm**, using solid carbide end mill as a boring tool, modification is needed. Adjusting range +0.01/+0.1.
- Boring size **above Ø5mm**, using solid carbide shank, insert type. Adjusting range ±0.1.

Application

- Replace end mill or reamer in small hole boring.
- Apply for electronic parts and micro machining parts.

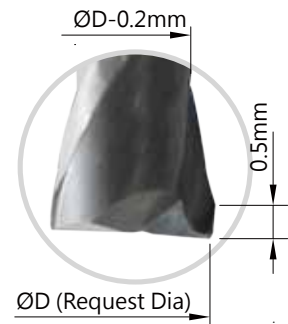

★ Cut down 0.2mm from original diameter, length is about 0.5mm count from the front edge. It is to avoid the interface while boring.

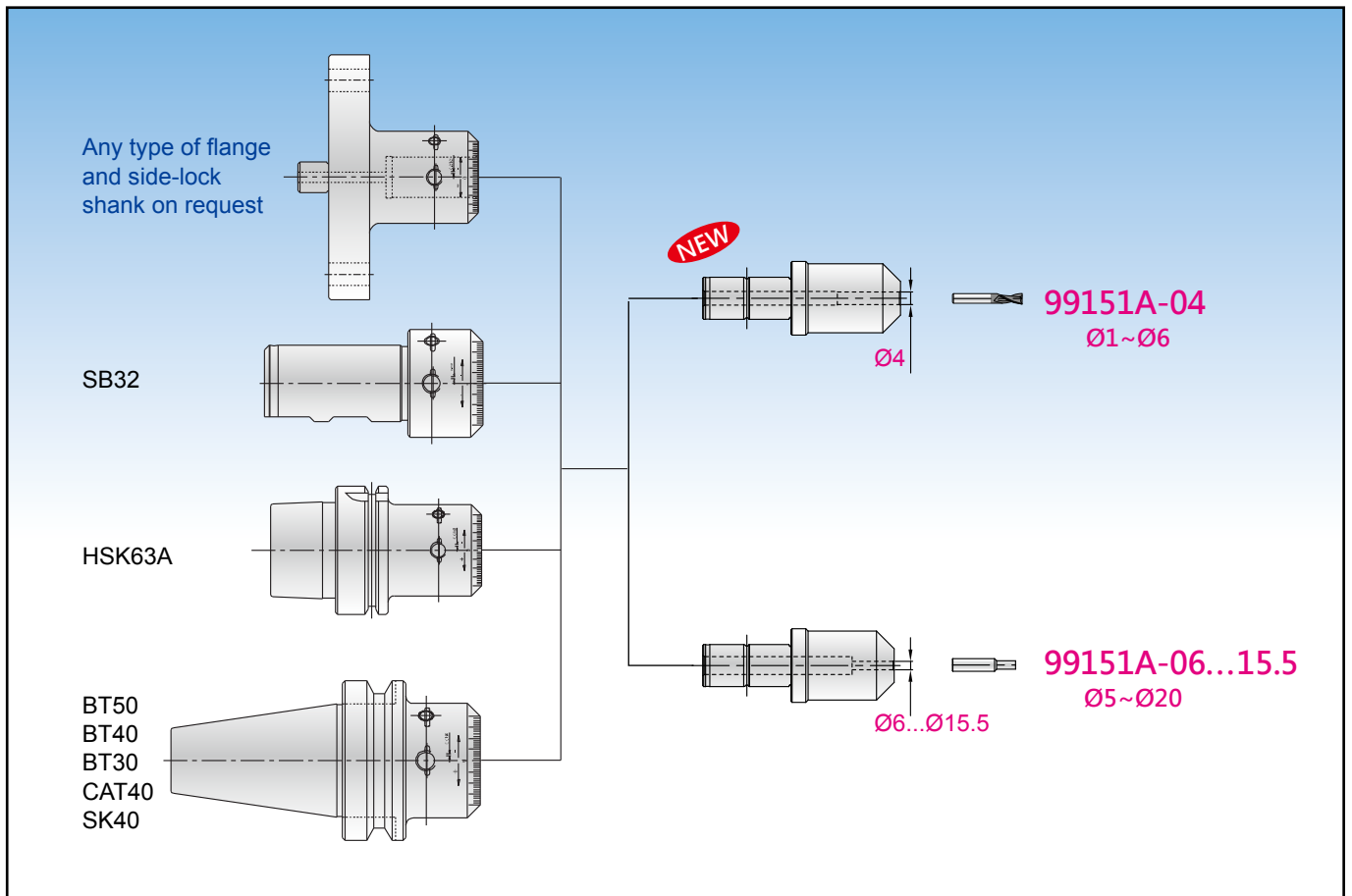

99151 Deep hole boring 4~6xD

Adapter

- Economical solution of small dia. boring bar.



Ordering Code	Part No.	ØD	L
00-99151A-04	C20-ID04	4	49
00-99151A-06	C20-ID06	6	52
00-99151A-08	C20-ID08	8	49
00-99151A-10	C20-ID10	10	42
00-99151A-11	C20-ID11	11	21.5
00-99151A-15.5	C20-ID15.5	15.5	21.5

Ø6.87~Ø11.12mm

- Solid Carbide Shank Ø8mm, Ø10mm
- Boring Depth : L1, 4~6xD

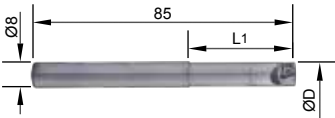

Ordering Code	Part No.	ØD	L1	Insert
00-99151-0700W	C08-0700-28L	6.87~7.12	28.00	CCGT040102-NC30 Screw: NS-20036 Key:NK-T6
00-99151-0725W	C08-0725-28L	7.12~7.37	28.00	
00-99151-0750W	C08-0750-30L	7.37~7.62	30.00	
00-99151-0775W	C08-0775-30L	7.62~7.87	30.00	
00-99151-0800W	C08-0800-32L	7.87~8.12	32.00	
00-99151-0825W	C08-0825-32L	8.12~8.37	32.00	
00-99151-0850W	C08-0850-34L	8.37~8.62	34.00	
00-99151-0875W	C08-0875-34L	8.62~8.87	34.00	

Ø11.87~Ø20.12mm

- Solid Carbide Shank
- Boring Depth : L1, 4~6xD

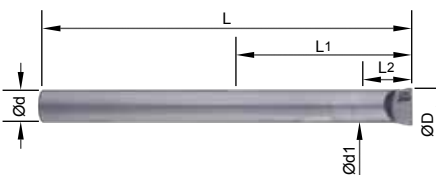

Fig. 1

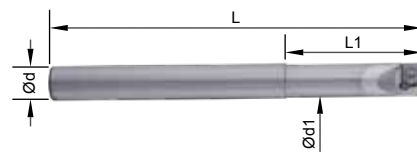
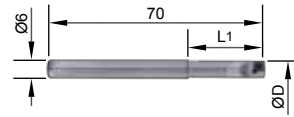

Fig. 2

Ordering Code	Part No.	ØD	Ød	Ød1	L1	L2	L	Fig.	Insert
00-99151-1200W	C11-1200-150L	11.87~12.12	11	11	70	20	150	1	CCGT060204 CCFT060204 Screw: NS-25045 Key:NK-T7
00-99151-1300W	C11-1300-150L	12.87~13.12	11	-	70	-	150		
00-99151-1400W	C11-1400-150L	13.87~14.12	11	-	70	-	150		
00-99151-1500W	C15.5-1500-90L	14.87~15.12	15.5	14	90	90	180	2	CCGT060204 CCFT060204 Screw: NS-25060 Key:NK-T7
00-99151-1600W	C15.5-1600-180L	15.87~16.12	15.5	15	90	90	180	1	
00-99151-1700W	C15.5-1700-180L	16.87~17.12	15.5	-	100	-	180		
00-99151-1800W	C15.5-1800-180L	17.87~18.12	15.5	-	100	-	180		
00-99151-1900W	C15.5-1900-180L	18.87~19.12	15.5	-	100	-	180		
00-99151-2000W	C15.5-2000-180L	19.87~20.12	15.5	-	100	-	180		

Ø4.87~Ø6.87mm

- Solid Carbide Shank Ø6mm
- Boring Depth : L1, 4~6xD



Ordering Code	Part No.	ØD	L1	Insert
00-99151-0500W	C06-0500-20L	4.87~5.12	20.00	CCGT030102-NC30 Screw: NS-16030 Key:NK-T6
00-99151-0525W	C06-0525-20L	5.12~5.37	20.00	
00-99151-0550W	C06-0550-22L	5.37~5.62	22.00	
00-99151-0575W	C06-0575-22L	5.62~5.87	22.00	
00-99151-0600W	C06-0600-24L	5.87~6.12	24.00	
00-99151-0625W	C06-0625-24L	6.12~6.37	24.00	
00-99151-0650W	C06-0650-26L	6.37~6.62	26.00	
00-99151-0675W	C06-0675-26L	6.62~6.87	26.00	

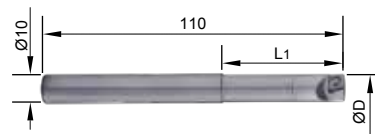

Ordering Code	Part No.	ØD	L1	Insert
00-99151-0900W	C10-0900-36L	8.87~9.12	36.00	CCGT060204 CCFT060204 All grades are available. Screw: NS-25045 Key:NK-T7
00-99151-0925W	C10-0925-36L	9.12~9.37	36.00	
00-99151-0950W	C10-0950-38L	9.37~9.62	38.00	
00-99151-0975W	C10-0975-38L	9.62~9.87	38.00	
00-99151-1000W	C10-1000-40L	9.87~10.12	40.00	
00-99151-1025W	C10-1025-40L	10.12~10.37	40.00	
00-99151-1050W	C10-1050-42L	10.37~10.62	42.00	
00-99151-1075W	C10-1075-42L	10.62~10.87	42.00	
00-99151-1100W	C10-1100-44L	10.87~11.12	44.00	

Precisely Ground Inserts

-CCGT030102, CCGT040102

- **NC30** : K20F carbide insert, TiAlN coated, universal grade for casting iron, carbon steel, alloy steel, stainless steel.

-CCGT040102, CCGT060204

- **NC2032** : K20F carbide insert, AlTiN coated, for high speed cutting of casting iron.
- **NC2033** : K20F carbide insert, TiAlN coated, good for carbon steel, alloy steel, stainless steel.
- **HP-NC9031**: K20F carbide insert, TiN coated, good for Al, Al-alloy, Copper and non ferrous metal.
- **NC9036** : K20F carbide insert, DLC coated, long tool life. Good for Al, Al-alloy, Copper and non ferrous metal.
- **U-NC9036** : K20F carbide insert, DLC coated, long tool life. It's a super finishing insert with large corner radius for high feed rate for cutting Al, Al-alloy and non-ferrous metal. (patent pending)
- **DM** : PCD brazed tipped insert with a polished and honed cutting edge for fine surface finished and longer tool life.



Inserts

Inserts	NC30	DM	NC2032	NC2033	NC9031	NC9036	Dimensions		
							lc	S	rε
CCGT030102	•						3.5	1.4	0.2
CCGT040102	•						4.3	1.8	0.2
CCGW040102		•					4.3	1.8	0.2
CCGH0602U						•	6.35	2.38	-
CCFT060204				•		•	6.35	2.38	0.4
CCFW060204			•				6.35	2.38	0.4
CCFT060204HP					•		6.35	2.38	0.4
CCMW060204		•					6.35	2.38	0.4

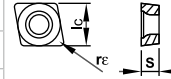

Cutting Data

- Note: Super fine finishing insert **U-NC9036** and **DM** with special specified cutting width **0.15mm**.(Radius) (see table below)

Formulas of spindle speed and feed rate :

Spindle speed $S = \frac{V_c \times 1000}{\pi \times D}$ r.p.m. Feed rate: $f \times S$ mm/min.

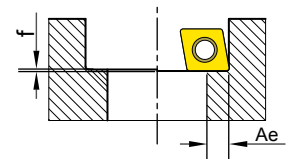

Material	Cutting conditions or surface finishes	Grade of insert	Ae Max mm	Cutting Speed Vc(m/min.)	feed rate f (mm/rev.)
Carbon Steel	Regular cutting	NC2033	0.5	120-150-200	0.05-0.07-0.10
	Interrupted cutting	NC30	0.3	100-120-140	0.04-0.05-0.08
Alloy Steel	Regular cutting	NC2033	0.5	100-120-140	0.05-0.07-0.10
	Interrupted cutting	NC30	0.3	80-100-120	0.04-0.05-0.08
Stainless Steel	Regular cutting	NC2033	0.5	80-100-120	0.05-0.07-0.10
	Interrupted cutting	NC30	0.3	70-80-100	0.05-0.07-0.10
Cast Iron	Regular cutting	NC2032 NC30	0.5	80-100-120	0.05-0.07-0.10
	Regular cutting	NC9036 NC9031	0.5	150-200-300	0.05-0.07-0.10
Brass, Bronze and Al-alloy Si >6%	Super mirror finish	U-NC9036	0.15	150-200-300	0.15-0.2-0.25
	Regular cutting	NC9036 NC9031	0.5	150-200-300	0.05-0.07-0.10
Al, Al-alloy, non-ferrous metal	Super finished	DM	0.3	500-1000-2000	0.05-0.07-0.10
	Super mirror finish	U-NC9036	0.15	150-200-300	0.15-0.20-0.25
	Regular cutting	NC30	0.3	80-100-120	0.04-0.06-0.08



Micro Adjustable Fine Boring Unit

EASY ADJUSTMENT

- High precision easy adjustment to accuracy of micron.
Each division diameter $20\mu\text{m}$, the adjusting diameter $2\mu\text{m}$
- with sub-scale (except size 1)

UNIVERSAL APPLICATIONS

- Micro adjustable fine boring unit is designed for building single and
- multi-step boring bars according to different boring range and applications.
- Mounting position is identical to numbers of other brand in the market.

MECHANICAL DESIGN

- Thanks to springforce, backlash is eliminated over the entire adjustment range.
- Easy procedures of cartridge changing to avoid damage.



Angular Mounting 90°

- Insert to be used: CCMT, CCMW, CCGH, CCGT, CCGX, TCMT, TCMW, TCGT, TCGX
- Maximum range can be checked by end of spanner.

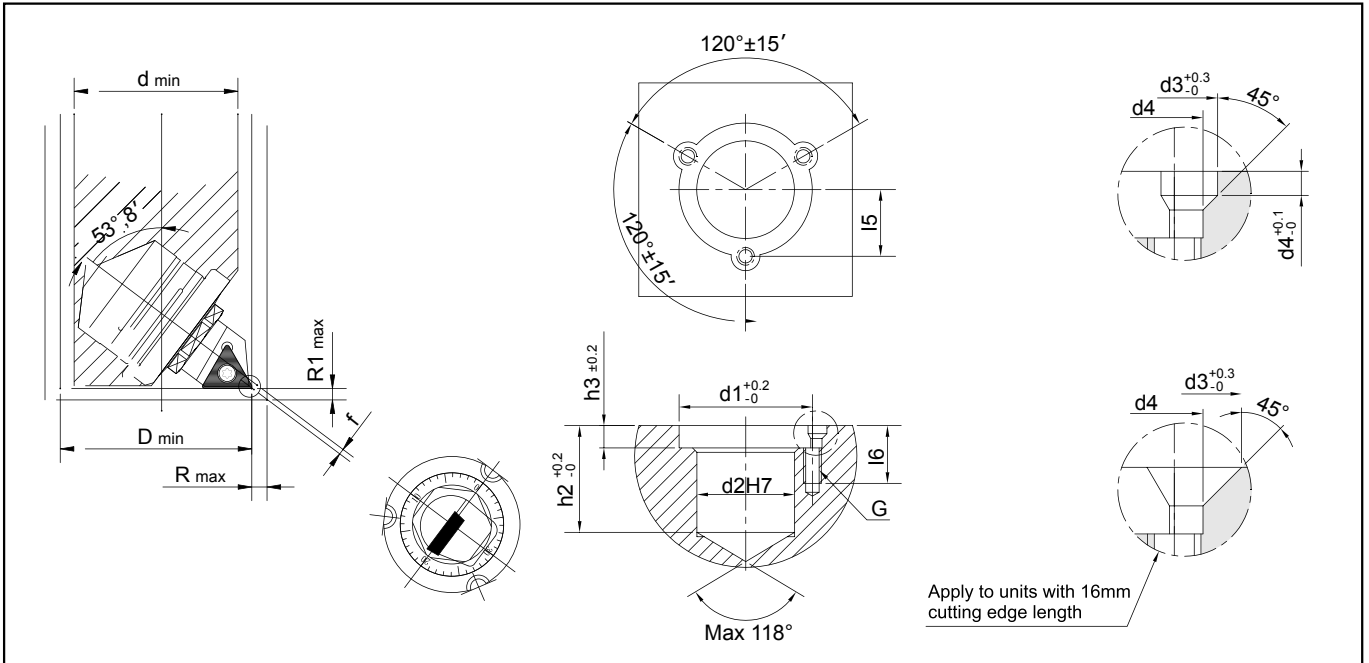

Ordering Code	Insert Shape	Insert Radius	Dimensions / mm						Mounting Dimensions / mm									
			d _{min}	D _{min}	R _{min}	R1 _{max}	f	h ₂	h ₃	h ₄	d ₁	d ₂	d ₃	d ₄	G	I ₆	I ₅	
99148-3106	06	0.2	22	25.7	2	1.5	0.40	11.5	2.8	1.6	19	16	4.6	3.2	M3	10	9.65 ±0.02	
		0.4		25.4														0.40
		0.8		24.8														0.45
99148-3209	09	0.2	28.5	33.4	2.8	2.1	0.95	15.5	4	1.6	25	20	4.6	3.2	M3	10	12.5 ±0.02	
		0.4		33.1														1.0
		0.8		32.5														1.1
99148-3311	11	0.2	38	42.9	4.8	3.6	1.15	24	5	1.8	30	22	6.5	4.3	M4	15	15.4 ±0.02	
		0.4		42.6														1.2
		0.8		42.0														1.3
99148-3416	16	0.2	55	60.6	8	6	1.3	33	6.3	-	46	32	11.9	5.4	M5	20	23 ±0.02	
		0.4		60.0														1.4
		1.2		59.4														1.5

Spare Parts For Setting And Clamping

Item	Insert Shape	Spanner	Mounting Screw	Insert Screw	Mounting Screw Key	Insert Screw Key	Mounting Screw Key
99148-3106	06	99148-3106-SP	99148-3106H	99148-3106I	NK-T9	NK-T7	-
99148-3209	09	99148-3209-SP	99148-3209H	99148-3209I	NK-T9	NK-T7	-
99148-3311	11	99148-3311-SP	99148-3311H	99148-3311I	NK-T15	NK-T7	-
99148-3416	16	99148-3416-SP	99148-3416H	99148-3416I	-	NK-T15	99148-3146-J

Micro Boring Unit



By add one screw to get greater precision

Advanced design

- The biggest advantage to add one **brass-head set screw** is to avoid any vibration when machining the bottom end of hole.
- It is to secure the MBU is well mounted in the pocket for stable boring process to get greater precision.
- Extend the tool life of boring insert.

Setscrew position of boring head

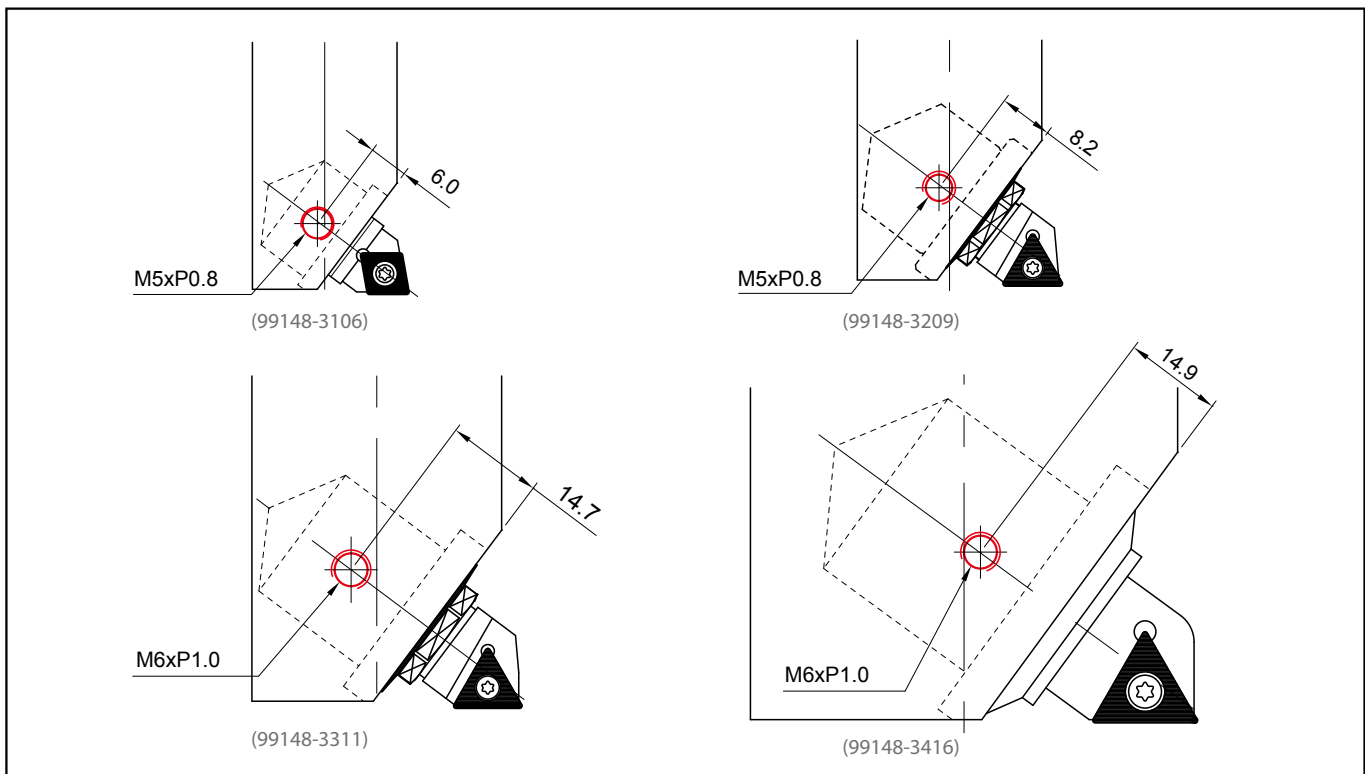

Ordering Code	MUB Type			Size	
				Illustration	<i>l</i>
00-NSC-50085	99148-3106		06		8.5
00-NSC-50085	99148-3209	09			8.5
00-NSC-60115	99148-3311	11			11.5
00-NSC-60115	99148-3416	16			11.5

Principle

- The adjustment mechanism is work by pushing the micrometric adjustment screw after the insert screw has been tighten, there is no backlash while adjusting boring diameter.

Procedures of Setting Boring Diameter

- Turn **screw-2** clockwise to the **bottom end** before tighten the insert.
- Tighten the insert by **screw 1**.
(If you have tool presetter, follow step 3-5; if you don't, jump to step 6-9.)
- Put the boring bar on the spindle of the tool presetter.
- Measure the diameter of the boring bar by tool presetter; it should be smaller than nominal diameter. Adjusting the diameter of the boring bar by turning **screw-2** counter-clockwise using the Allen-key to increase diameter until required diameter is achieved.
- If the diameter has been adjusted too big, please loosen the **screw-2**, and then **screw-1**. Repeat step 2-4 until the required diameter is achieved.
- Put the boring bar on the machine spindle and make a test cut, about 5 mm deep. Measure hole diameter of the test cut.
- Moving the boring bar to the tool diameter setter. The insert of the boring bar should touch the ceramic probe gently. Setting the dial gage to "zero" and adjust diameter by turning screw-2 counter-clockwise using the Allen key.
- Read and note the "Adjusting amount" on the dial gage.
 $\text{Adjusting amount} = (\text{Nominal diameter} - \text{test cut diameter}) / 2$ (mm or inch.)
- Make test cut and measure again until required adjusting amount is achieved.

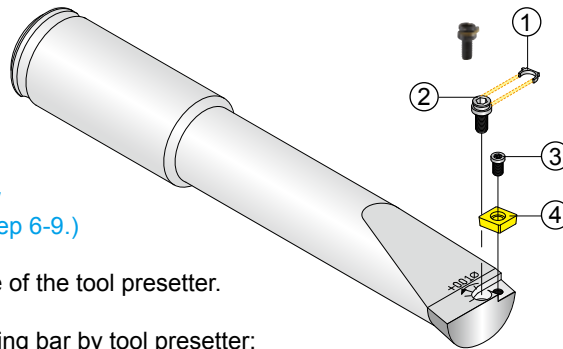

- Slide wedge
- Micrometric adjustment screw
- Insert lock screw
- Insert

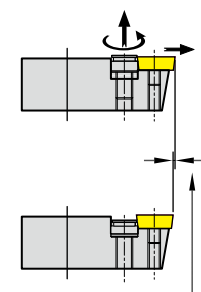
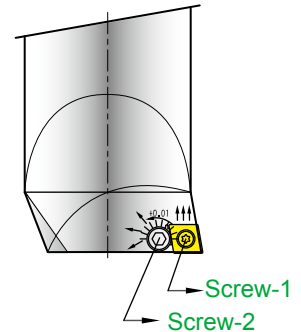

Adjusting Range 0.2 mm

Adjusting boring diameter on the presetter.



Direction to increase boring diameter.

99043 Direct Adjusting Boring Bar

Screw Fit Boring head

- Integrated with direct adjustment for fine boring, each division is $\varnothing 0.01\text{mm}$.
- Total adjustment range: 0.2mm
- Extension bar is TiN coated to show the maximum usable boring length.

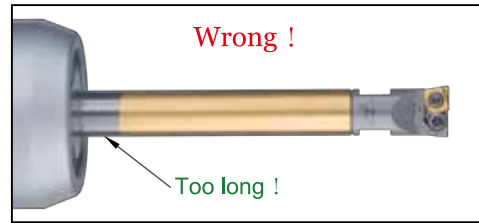
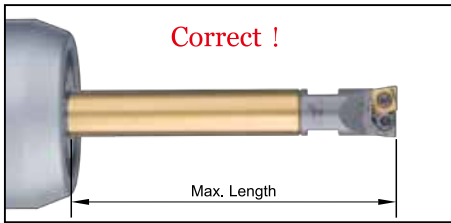

Order No.	Part No.	$\varnothing D$	L	M		Insert
00-99043-14	M6-FB14	13.9~14.1	25	M6xP1.0	99801-12	CC060204 Screw: NS-25045 Key:NK-T7
00-99043-15	M6-FB15	14.9~15.1	25	M6xP1.0	99801-12	
00-99043-16	M8-FB16	15.9~16.1	25	M8xP1.25	99801-14	
00-99043-17	M8-FB17	16.9~17.1	25	M8xP1.25	99801-14	CC060204 Screw: NS-25060 Key:NK-T7
00-99043-18	M8-FB18	17.9~18.1	25	M8xP1.25	99801-16	
00-99043-19	M8-FB19	18.9~19.1	30	M8xP1.25	99801-16	
00-99043-20	M10-FB20	19.9~20.1	30	M10xP1.5	99801-18	
00-99043-21	M10-FB21	20.9~21.1	30	M10xP1.5	99801-18	
00-99043-22	M10-FB22	21.9~22.1	30	M10xP1.5	99801-20	
00-99043-23	M10-FB23	22.9~23.1	30	M10xP1.5	99801-20	
00-99043-24	M10-FB24	23.9~24.1	30	M10xP1.5	99801-20	
00-99043-25	M10-FB25	24.9~25.1	30	M10xP1.5	99801-20	

Steel - Extension Bar

- Made by steel, hardened, TiN coated range is the maximum boring length.

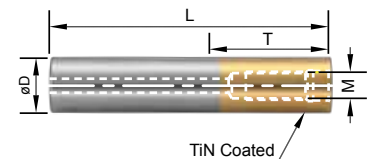

Order No.	Part No.	$\varnothing D$	T	L	M
00-99801-12S	BC12-075M06S	12	25	75	M6xP1.0
00-99801-14S	BC14-090M08S	14	30	90	M8xP1.25
00-99801-16S	BC16-090M08S	16	35	90	M8xP1.25
00-99801-18S	BC18-100M10S	18	40	100	M10xP1.5
00-99801-20S	BC20-100M10S	20	40	100	M10xP1.5
00-99801-25S	BC25-120M12S	25	50	120	M12xP1.75

Solid Carbide Extension Bar

- Made by solid carbide, TiN coated range is the maximum boring length.

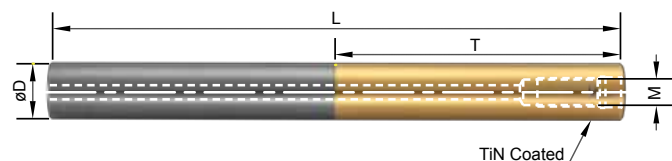

Order No.	Part No.	$\varnothing D$	T	L	M
00-99801-12W	BC12-100M06W	12	60	100	M6xP1.0
00-99801-14W	BC14-120M08W	14	70	120	M8xP1.25
00-99801-16W	BC16-150M08W	16	80	150	M8xP1.25
00-99801-18W	BC18-150M10W	18	90	150	M10xP1.5
00-99801-20W	BC20-200M10W	20	100	200	M10xP1.5
00-99801-25W	BC25-200M12W	25	125	200	M12xP1.75

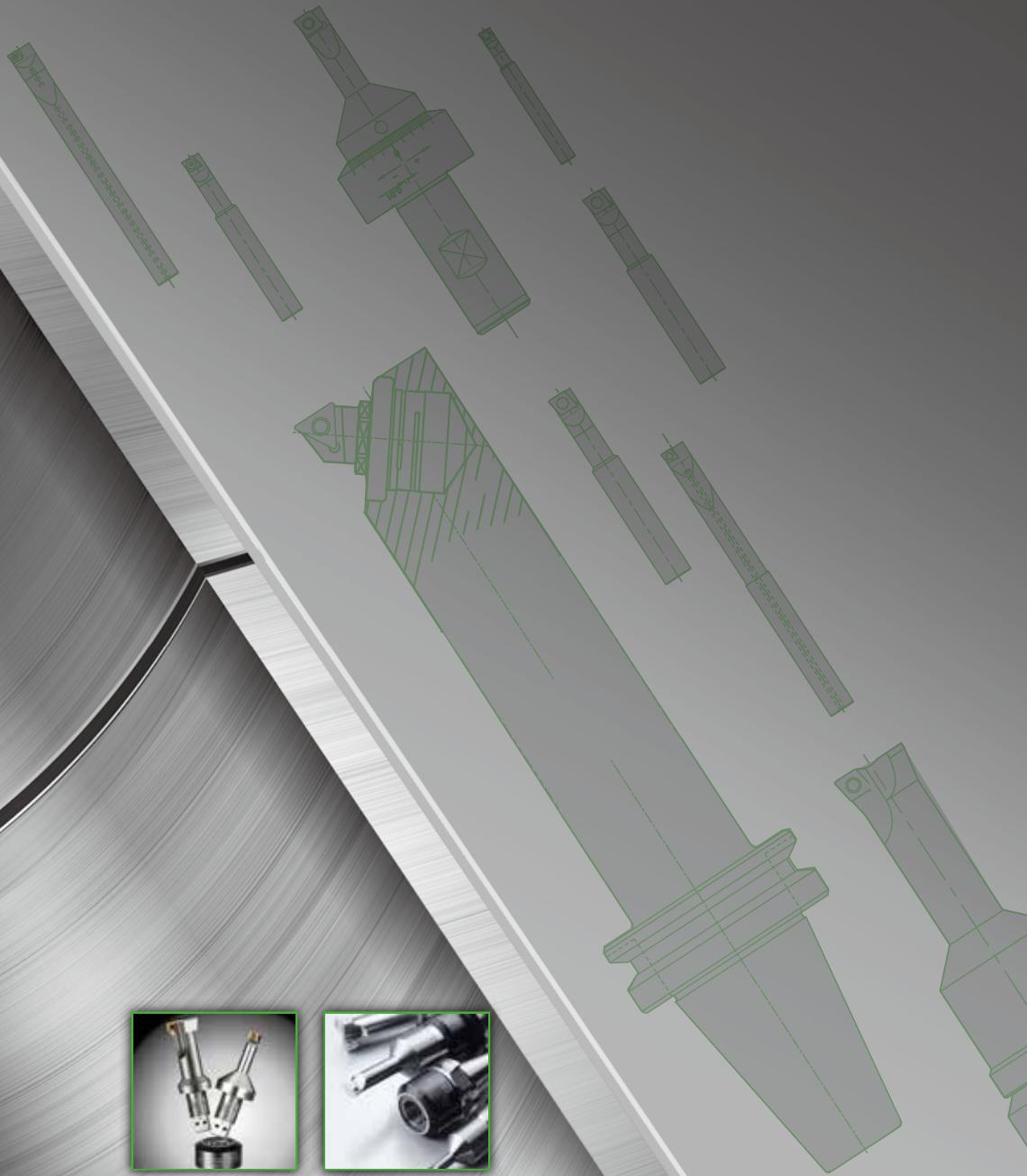

HIGH SPEED BORING TOOL Highlight of Product



Jimmore International Corp.

Distributor

*subject to change without notice